

F170-330

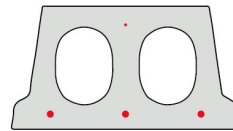

Technische info

Hoogte	173mm
Breedte	330mm
Lengte	Wap. S350: 0,70m => 2,40m op bestelling (per 10cm oplopend)
	Wap. S350: 2,50m => 6,50m uit voorraad (per 10cm oplopend)
	Wap. S350: 6,60m => 7,00m op bestelling (per 10cm oplopend)
	Wap. S700: 0,70m => 4,60m op bestelling (per 10cm oplopend)
	Wap. S700: 4,70m => 6,50m uit voorraad (per 10cm oplopend)
	Wap. S700: 6,60m => 7,00m op bestelling (per 10cm oplopend)
Brandweerstand	1 uur (2u op bestelling)
Milieuklasse	XC1; XC2, XC3 (andere op bestelling)
Transportgewicht	2,25 kN/m ²
Gewicht/ m	0,74 kN/m
Rekengewicht	3,00 kN/m ²
Kanaalvulling	7,43 l/m
Vulbeton	30 l/m ²
Betonkwaliteit	C 40/50
Staalkwaliteit	f(yk) 500; f(tk) 550

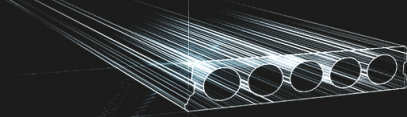

Overspanningen

Maximale Elementlengte F170-330 RUW							
Wapeningstype		S350		S700		Max	
Druklaag		0cm	5cm	0cm	5cm	0cm	5cm
Nuttige Belasting (kN/m ²)	3,00	5,70m	6,70m	5,70m	7,00m	6,00m	7,00m
	3,50	5,50m	6,50m	5,50m	6,70m	5,80m	6,70m
	4,00	5,10m	5,90m	5,30m	6,50m	5,50m	6,50m
	5,00	4,70m	5,70m	4,90m	5,70m	5,20m	6,10m
	6,00	2,10m	5,40m	4,60m	5,40m	4,90m	5,70m
	7,00	2,00m	4,70m	4,30m	5,10m	4,60m	5,50m
	8,00	1,90m	2,10m	4,10m	4,90m	4,40m	5,20m
	9,00	1,80m	2,00m	3,90m	4,70m	4,20m	5,00m
10,00	1,80m	2,00m	3,00m	4,50m	4,10m	4,80m	

*De waardes zijn berekend met een opleg van 7cm aan beide uiteinden

Booradvies

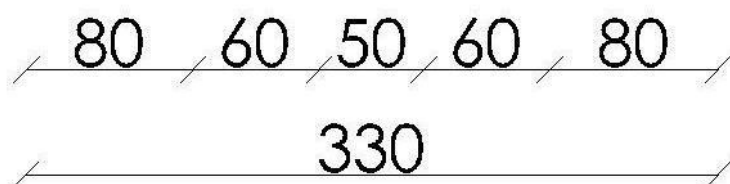
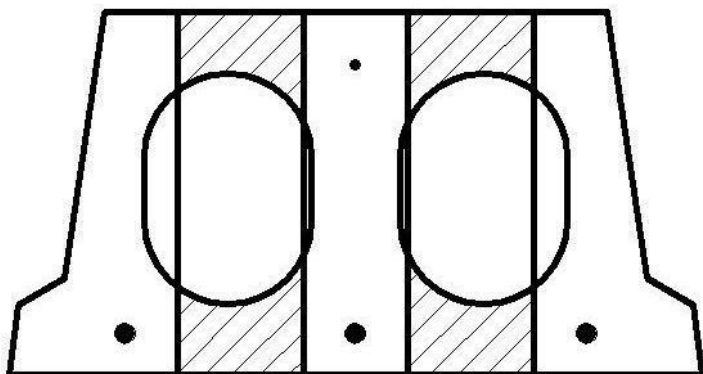
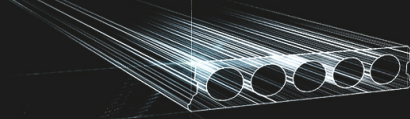

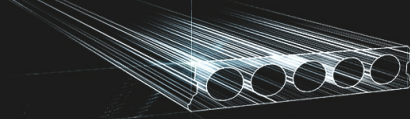

Wapeningspositie

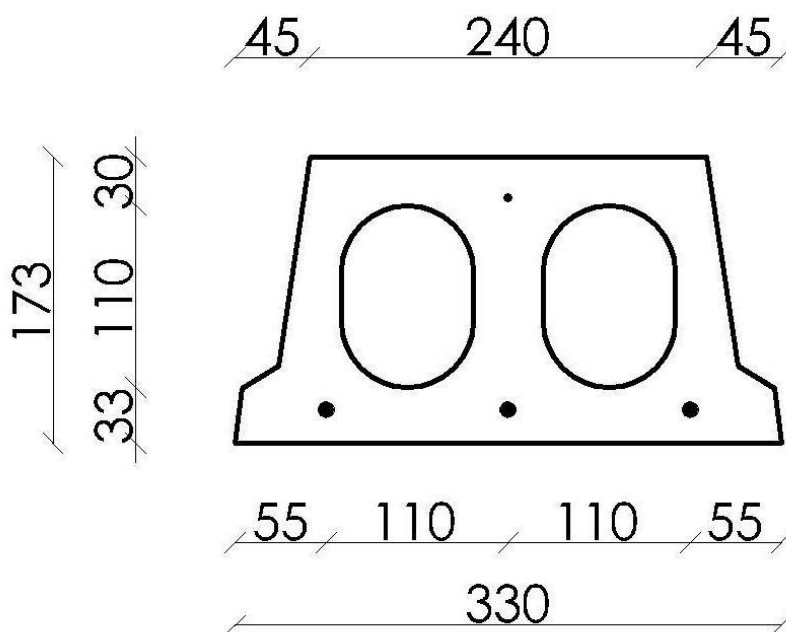

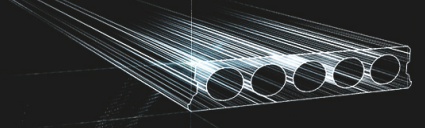

Supplementen

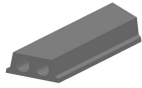

Schuinzagen/inkorten

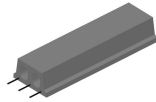

Uitstekende wapening



Verdunde onderzijde

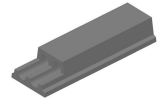

Verdunde bovenzijde

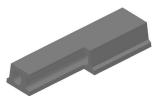

Hoeksparing



Kopsparing



Ronde sparing

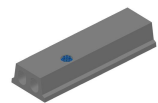

Ronde sparing + CD

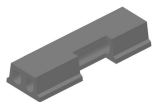

Zijsparing

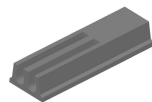

Opengemaakte kanalen



Raveelijzers - Gewapend

Voorraad

	Productie	Afhaalbaar	Op voorraad
Malle 1	X	X	X
Malle 2			
Frederickx		X	
Tessenderlo			

Gedownload op: 02/06/2020 03:20:45