

F130-330

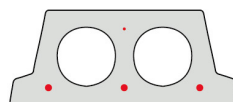

Technische info

Hoogte	130mm
Breedte	330mm
Lengte	Wap. S350: 0,70m => 5,40m uit voorraad (per 10cm oplopend) Wap. S350: 5,50m => 5,90m op bestelling (per 10cm oplopend) Wap. S700: 0,70m => 5,40m uit voorraad (per 10cm oplopend)
Brandweerstand	1 uur (2u op bestelling)
Milieuklasse	XC1; XC2; XC3 (andere op bestelling)
Transportgewicht	1,60 kN/m ²
Gewicht/ m	0,53 kN/m
Rekengewicht	2,15 kN/m ²
Kanaalvulling	5,41 l/m
Vulbeton	22 l/m ²
Betonkwaliteit	C 40/50
Staalkwaliteit	f(yk) 500; f(tk) 550

Gedownload op: 05/06/2020 23:42:29



Fingo
Malle 1 Nijverheidsstraat 21
Malle 2 Industrieweg 22
Malle B-2390
+32 (0)3 309 26 26

Fingo Tessenderlo
Truibroek 76
Ham B-3945

fingo@fingo.be

Fingo - Frederickx
Schuttersveldstraat 11
Messelbroek B-3270
+32 (0)13 78 00 78

pagina 1 / 4

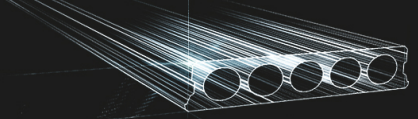

Overspanningen

Maximale Elementlengte F130-330 RUW							
Wapeningstype		S350		S700		Max	
Druklaag		0cm	5cm	0cm	5cm	0cm	5cm
Nuttige Belasting (kN/m ²)	3,00	4,30m	5,40m	4,40m	5,40m	4,50m	5,50m
	3,50	3,90m	5,10m	4,20m	5,30m	4,30m	5,30m
	4,00	3,00m	4,90m	4,00m	5,10m	4,10m	5,10m
	5,00	2,00m	2,20m	3,60m	4,80m	3,80m	4,80m
	6,00	1,90m	2,10m	3,30m	4,50m	3,60m	4,50m
	7,00	1,80m	2,00m	3,10m	4,10m	3,40m	4,30m
	8,00	1,70m	1,90m	2,30m	3,90m	3,20m	4,10m
	9,00	1,60m	1,90m	1,90m	3,70m	3,10m	3,90m
	10,00	1,50m	1,80m	1,50m	3,10m	3,00m	3,80m

*De waardes zijn berekend met een opleg van 7cm aan beide uiteinden

Booradvies

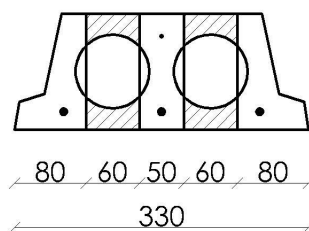

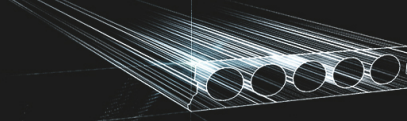

Wapeningspositie

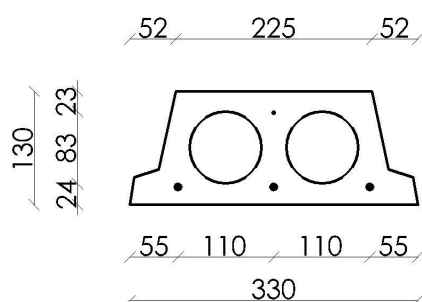

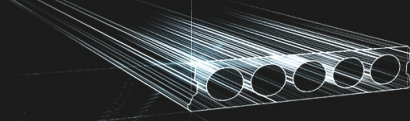

Supplementen



Schuinzagen/inkorten

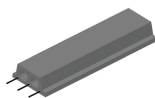

Uitstekende wapening



Verdunde onderzijde

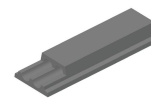

Verdunde bovenzijde



Hoeksparing



Kopsparing



Ronde sparing



Ronde sparing + CD

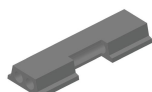

Zijsparing



Opengemaakte kanalen



Raveelijzers - Gewapend

Voorraad

	Productie	Afhaalbaar	Op voorraad
Malle 1	X	X	X
Malle 2			
Frederickx			
Tessenderlo			

Gedownload op: 05/06/2020 23:42:29