

FS400-1200

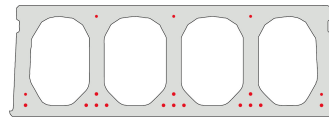

Informations techniques

Epaisseur	400mm
Largeur	1200mm
Résistance au feu	1 uur (2u op bestelling)
Classes d'exposition	XC1; XC2; XC3 (andere op bestelling)
Poids au transport	4,32 kN/m ²
Poids/ m	5,18 kN/m
Poids de calcul	4,68 kN/m ²
Kanaalvulling	64,23 l/m
Béton de remplissage	13,6 l/m ²
Qualité du béton	C 50/60
Qualité d'acier	f(pk) 1860; f(p0,1k) 1580

Travées

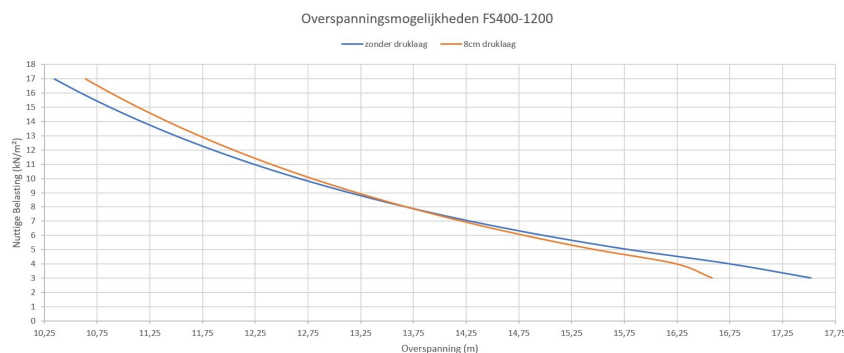

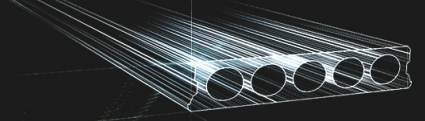

Plaques d'ajustage

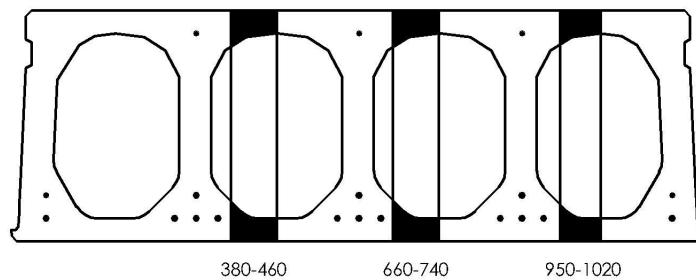

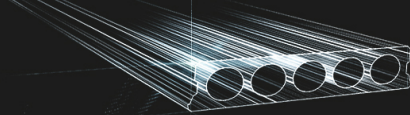

Conseil de forage

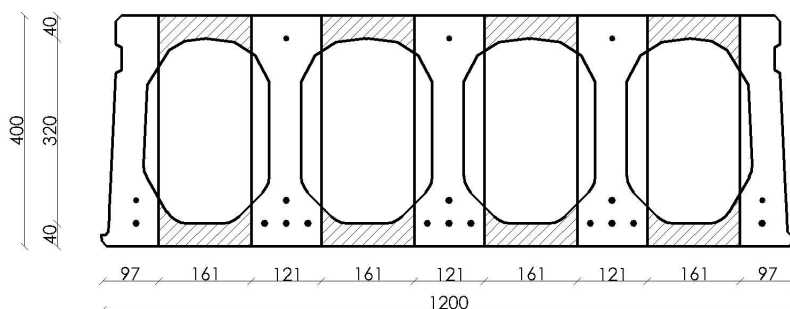

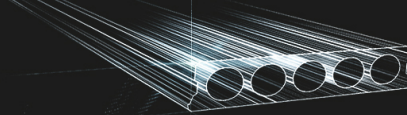

Position d'armature

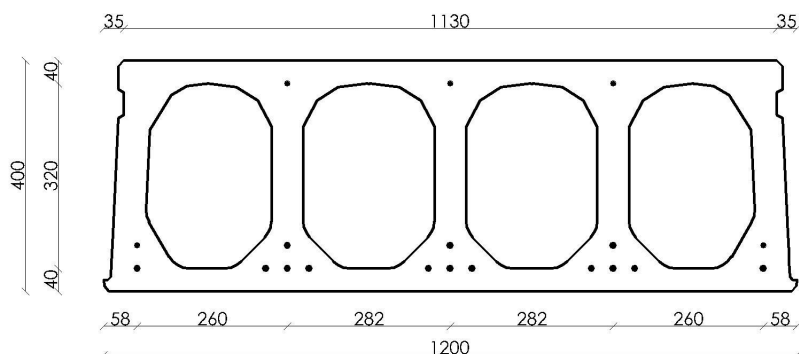

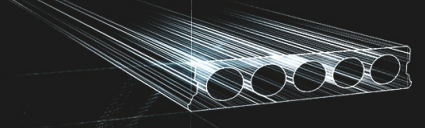

Suppléments

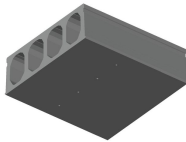

Trous de drainage d'eau

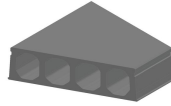

Sciage en coupe oblique

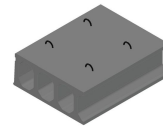

Boucles de levage

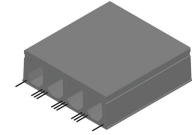

Armatures dépassantes

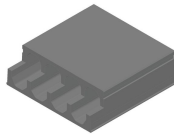

Amincissement supérieur



Evidement angulaire

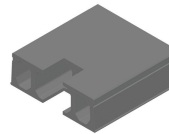

Evidement de tête

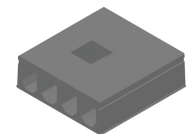

Evidement central

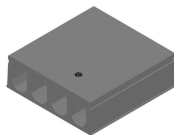

Evidement Ø90 + boîte de dérivation

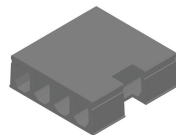

Evidement latéral

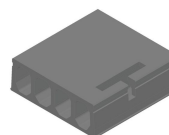

Tête de marteau

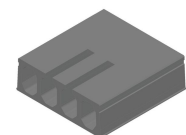

Alvéoles ouvertes



Raveelijzers



Évidement partiel

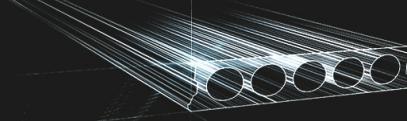

Stock

	Production	Emporter	Stock
Malle 1			
Malle 2	X	X	
Frederickx			
Tessenderlo	X	X	

gedownload op: 08/03/2021 00:23:28



Fingo
Malle 1 Nijverheidsstraat 21
Malle 2 Industrieweg 22
Malle B-2390
+32 (0)3 309 26 26

Fingo Tessenderlo
Truibroek 76
Ham B-3945

fingo@fingo.be

Fingo - Frederickx
Schuttersveldstraat 11
Messelbroek B-3270
+32 (0)13 78 00 78

page 6 / 6