

F130-330

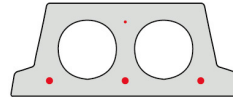

Informations techniques

Epaisseur	130mm
Largeur	330mm
Longueur	Armature S350: 0,70m => 5,40m de stock (par 10 cm) Armature S350: 5,50m => 5,90m sur commande (par 10 cm) Armature S700: 0,70m => 5,40m de stock (par 10 cm)
Résistance au feu	1 heure (2 heures sur commande)
Classes d'exposition	XC1, XC2, XC3 (d'autres sur commande)
Poids au transport	1,60 kN/m ²
Poids/ m	0,53 kN/m
Poids de calcul	2,15 kN/m ²
Remplissage d'alvéole	5,41 l/m
Béton de remplissage	22 l/m ²
Qualité du béton	C 40/50
Qualité d'acier	f(yk) 500; f(tk) 550

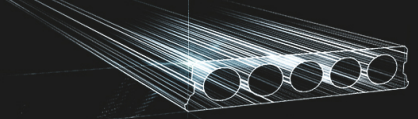

Travées

Maximale Elementlengte F130-330 RUW							
Wapeningstype		S350		S700		Max	
Druklaag		0cm	5cm	0cm	5cm	0cm	5cm
Nuttige Belasting (kN/m ²)	3,00	4,30m	5,40m	4,40m	5,40m	4,50m	5,50m
	3,50	3,90m	5,10m	4,20m	5,30m	4,30m	5,30m
	4,00	3,00m	4,90m	4,00m	5,10m	4,10m	5,10m
	5,00	2,00m	2,20m	3,60m	4,80m	3,80m	4,80m
	6,00	1,90m	2,10m	3,30m	4,50m	3,60m	4,50m
	7,00	1,80m	2,00m	3,10m	4,10m	3,40m	4,30m
	8,00	1,70m	1,90m	2,30m	3,90m	3,20m	4,10m
	9,00	1,60m	1,90m	1,90m	3,70m	3,10m	3,90m
	10,00	1,50m	1,80m	1,50m	3,10m	3,00m	3,80m

*De waardes zijn berekend met een opleg van 7cm aan beide uiteinden

Conseil de forage

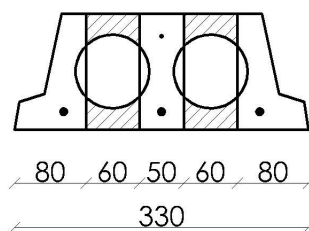

Téléchargé sur : 03/12/2021 14:46:54

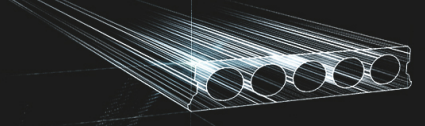

Position d'armature

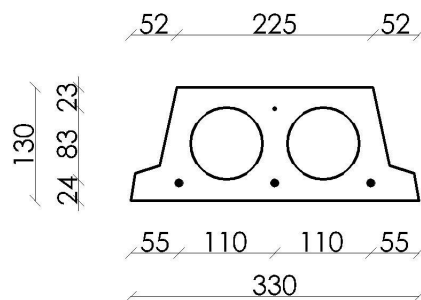

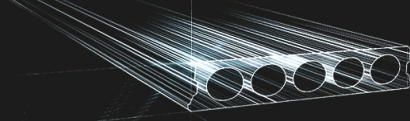

Suppléments



Stock

	Production	Emporter	Stock
Malle 1	X	X	X
Malle 2			
Frederickx			
Tessengerlo			

Téléchargé sur : 03/12/2021 14:46:54